

Ai Bi FIXING INSTRUCTIONS

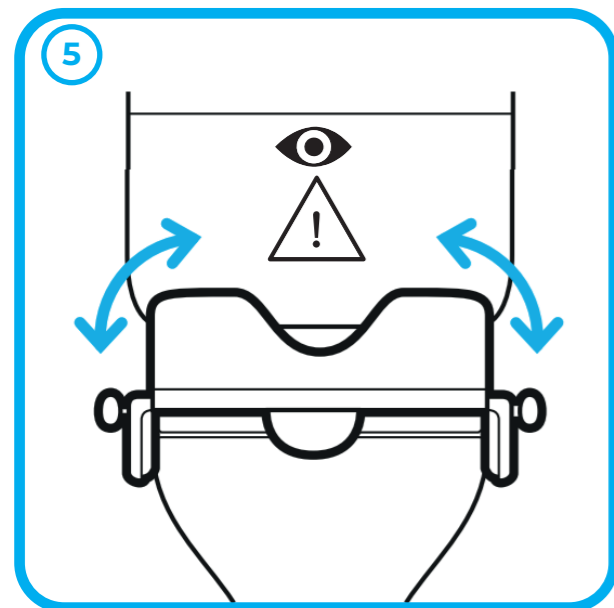

ci ATTACHING A LID

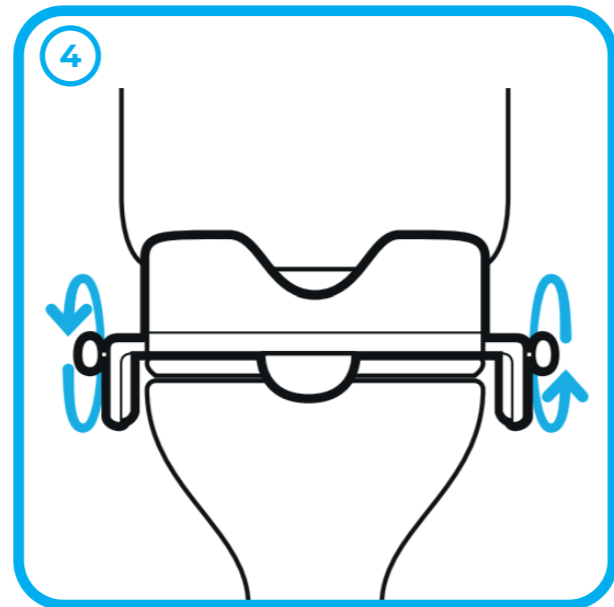
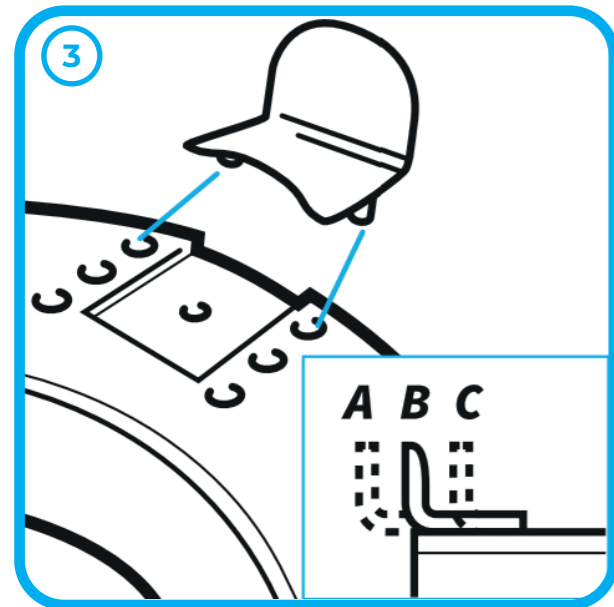
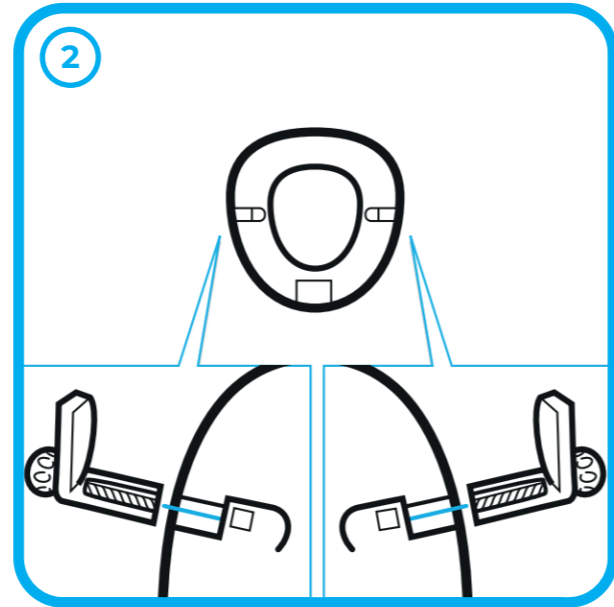
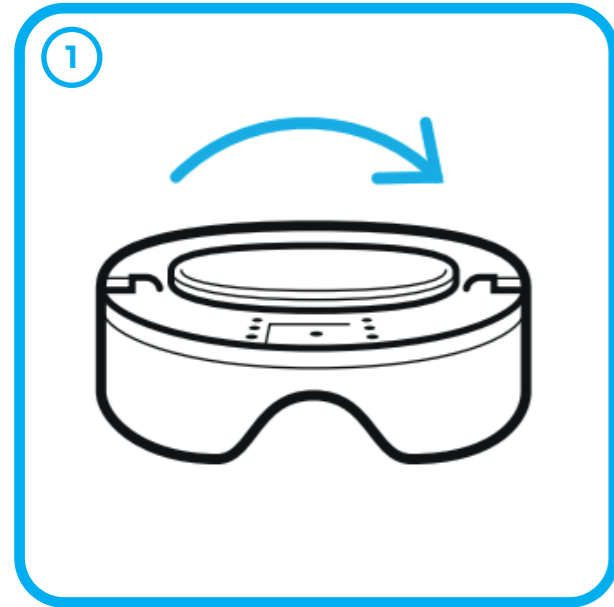
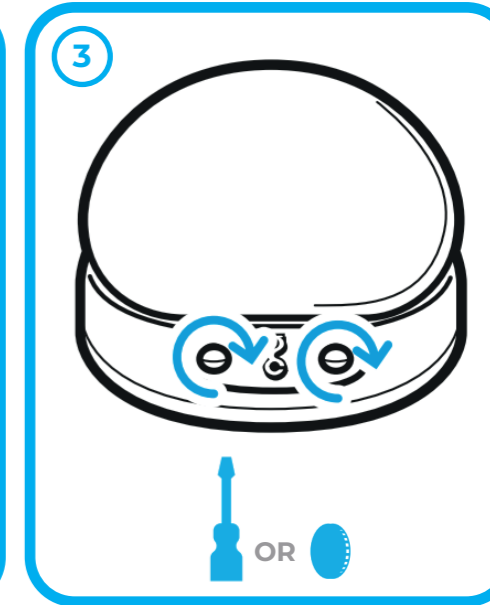
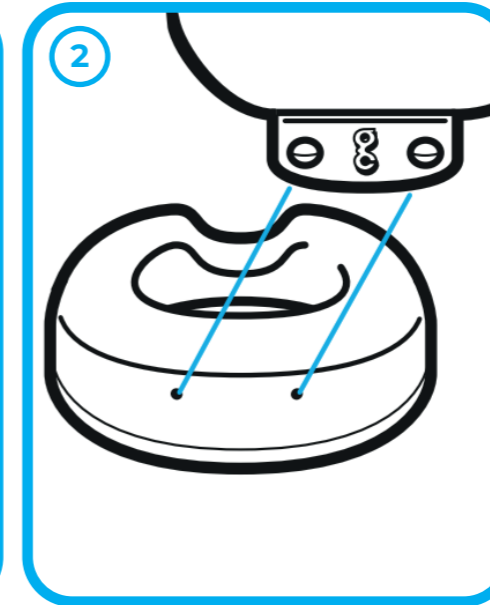
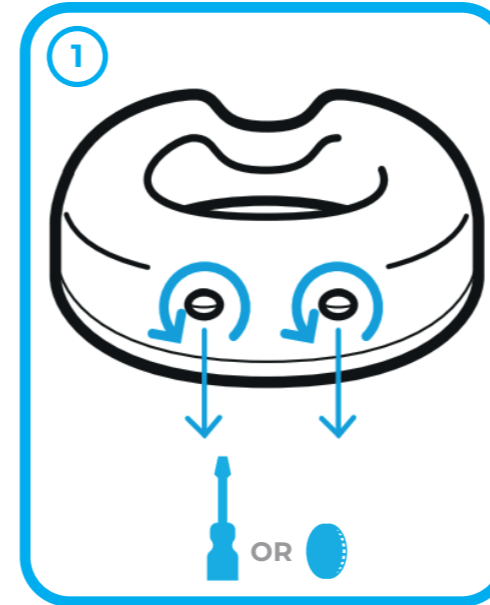

Ai Bi ATTACHING A P-GUARD

