

The Child Restraint System for Special Needs **CARROT-3**

Instruction Manual

Read carefully all the instructions before use.

CARROT 3



When not in use,
store in the pocket
on the back for
future use.

Carrot-3 “ Special Needs Restraint ” is designed to give extra support to children who have difficulty in sitting correctly in conventional seats. Always consult your doctor to make sure that this restraint system is suitable for your child, and read all the instructions in this manual before use.

EU conformity declaration for medical products (according Article 19 and Annex IV, Regulation (EU) 2017/745 (MDR) of 5 April 2017 on medical devices: We declare hereby that the car seat Carrot-3 conforms with the equivalent rules of the Regulation (EU) 2017/745 (MDR) of 5 April 2017 on medical devices. The production of the Carrot-3 is controlled by a quality management system according EN ISO 9001 under consideration of the Regulation (EU) 2017/745 (MDR) of 5 April 2017 on medical devices.

Our product identification is located on the back of the Carrot 3 car safety seat under the cover on the right.

Manufacturer:

SEEDS Co., Ltd.
705-16, Meshiro,
Isahaya, Nagasaki,
854-0007 Japan

Producing Plant:

Marubishi Industry Co., Ltd.
1251-3, Honjo,
Komaki, Aichi,
485-8505 Japan

Sole importer in Europe and authorized representative for the EU medical devices market:

RehaNorm GmbH & Co. KG,
Am Ockenheimer Graben 50,
55411 Bingen Germany
Phone: +49 67 21/90 60, Fax: +49 67 21/90 66 6,
E-Mail: info@rehanorm.de, www.rehanorm.de



Table of Contents

Warnings	3
Safety Information	5
Important Notes	5
Certification	6
Features	7
Installation	9
Standard Installation.....	9
Aircraft Installation	10
Functions	13
Head Section	13
Head Support Depth Adjustment.....	13
Head Pillow Adjustment	13
Shoulder Section	14
Harness Strap Adjustment	14

Table of Contents

Harness Strap Length Adjustment	14
Shoulder Strap Comfort Pad	15
Shoulder Protector Wing.....	15
Adjusting Shoulder Width	15
Shoulder Protector Wing Installation	16
Chest Section	17
Adjusting Chest Support	17
Fastening / Releasing Harness Buckle.....	17
Backrest Section	18
Adjusting Backrest Height	18
Backrest Extensions (50 mm / 100 mm).....	18
Side Impact Cushion Pads.....	19
Seat Section	20
Adjusting Seat Length	20
Seat Extensions (50 mm / 100 mm).....	20
Rodded Seat Extension-Long.....	20
Rodded Seat Extension-Short.....	20
Adjusting Seat Depth.....	21
Foot Rest (Short / Medium / Long)	21
Supporting Table	21
Seat Angle Adjuster Mat (Triangle Mat).....	21
Pads and Cushions / Standard Accessories.....	22
Anti Adduction / Knee Separator Pad	23
Removable Incontinence Receiver	23
Anti-Escape Vest.....	24
Hinge Lock Belt - for easy carrying.....	24
Securing Your Child	25
Care And Maintenance	28
Cover Removal.....	28
Cleaning the Cover, Pillow and Pads	28
A Click Sound of the Harness Buckle.....	28
The Harness and the Straps.....	28
Product Dimensions	29
Warranty	30
LIMITED TWO-YEAR WARRANTY.....	30
WARRANTY LIMITATIONS	30
LIMITATION OF DAMAGES.....	30
LIMITED TWO-YEAR WARRANTY	31



WARNING! **DEATH or SERIOUS INJURY can occur**

- Carrot 3 has been tested and approved as a universal restraint device in terms of the Medical Devices Act and is not subject to any other standard. Carrot 3 has also been successfully tested in according to UN ECE R129/03 with Q3 dummy (small seat configuration for children from 80 to 95 cm) and Q10 dummy (large seat configuration for children from 95 cm to 150 cm). The legal situation in several countries (like in Germany) allows to transport children with less than 15 kg and young patients between 36 and 50 kg. In most countries, you need a written document of a doctor, which says that it belongs to the special needs of this special patient to use this seat.
- Use forward-facing position only.
- Do never change anything on the construction of the Carrot-3, unless this is specially authorized in this instruction manual.
- Adjust the belts provided with this child seat so they fit snugly around your child. A snug strap should not allow any slack or twist. It does not press on the child's flesh or push the child's body into an unnatural position.
- Secure this child seat with the upper and lower fixing straps to the vehicle's seat, and always use vehicle's lap shoulder (3-point) safety belts as well.
- Fasten the harness (5-point) of the child seat as well as the vehicle's lap shoulder (3-point) safety belt to secure your child in a firm position.
- Follow all the instructions on this child seat and in this instruction manual.
- Use this child seat only with the vehicles provided with lap shoulder (3-point) safety belts approved by ECE regulation No.16 or other equivalent standards.
- The rigid items and plastic parts of the child restraint must be so located and installed that they are not liable, during everyday use of the vehicle, to become trapped by a movable seat or in a door of the vehicle.
- To prevent injury due to hidden damage, discontinue use of a child seat that has been in a moderate or severe crash.
- This child seat must not be used without the cover.
- The child seat cover should not be replaced with any other than the one recommended by the manufacturer.



WARNING! **DEATH or SERIOUS INJURY can occur**

- When not in use, this instruction manual should be stored in the pocket on the back.
- This child seat must not be used in the home, in boats, or other non-certified applications.
- Back seat of vehicle is the safest location for a properly installed child seat. Please study and ensure your child's safety and consult your vehicle owner's manual.
- Secure this child seat even when it is not occupied. In a crash, an unsecured child seat may injure vehicle occupants.
- When using in a vehicle with airbags, refer to your vehicle's owner's manual for child seat installation instructions and precautions.
- Never use the adjuster strap to lift or carry this child seat. Doing so could cause damage to harness adjuster and webbing. Always carry this child seat by its shell.
- Do not take apart or attempt to take apart the harness and the straps from the child seat. Never remove the buckles and / or the buckle tongues from the harness or the straps. They cannot be reattached after removal. If reassembled incorrectly, the child seat may not perform as intended.
- Follow all instructions on this child restraint and in the written instruction manual located in the pocket behind the unit.
- Never use the adjustment straps to lift or carry this restraint. This can damage the mechanism and the webbing.
- Do not remove the harness and straps from the child seat. Never remove the buckles and/or the buckle clasps from the harness or the straps.
- The primary protection for occupants of a vehicle in a collision is the body of the vehicle itself ; a child seat will not protect a child when a vehicle is seriously impacted. However, correctly installed, a child seat will substantially improve chances for survival in most crashes. Make sure all users fully understand the correct ways to use this child seat in a vehicle.



Safety Information

Important Notes

- Verify child seat is securely installed / fixed to car seat with provided upper and lower fixing straps, and harness is properly adjusted around child each time child seat is used.
- Adjust harness to fit clothes the child is wearing. Remove bulky coats and / or jackets before putting child in child seat.
- Cover child seat when vehicle is parked in direct sunlight. Parts of child seat could become hot enough to burn a child.
- Store child seat in a safe place when it is not being used. Avoid placing heavy objects on top of it.
- Do not leave children alone in a vehicle, even for a short time.
- Do not, except as described in this manual, attempt to disassemble any part of the child seat or change the way its harness or vehicle's seat belts are used.
- Do not leave loose objects, e.g. books, bags, etc., in the back of a vehicle. In the event of a sudden stop, loose objects will keep moving, potentially causing serious injuries.
- Do not leave folding vehicle seats unlatched. In the event of a sudden stop, a loose seat back could prevent child seat from protecting the child as well as it should.
- Do not use anything to raise child seat off vehicle seat except as described in this manual. In a crash, child seat could slide and may not adequately protect the child.
- Do not allow children to play with this or any child seat.
- This child seat is recommended to be used in the upright position.



Safety Information

Certification

This child seat has been successfully tested in according to European Safety Standard UN ECE R129/03.



WARNING!

This child restraint must be used in a forward-facing position only.



WARNING!

Before reclining the back, you must release and loosen the harness straps (Fig. 1). Once reclined, re-tighten the harness straps (Fig. 2).

Reclining the back without loosening the harness straps may cause choking.

The Carrot-3 was tested at a 30° recline from vertical, and should not be transported in a moving vehicle past this point.

(Fig.1)

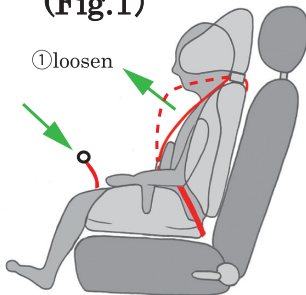

(Fig.2)

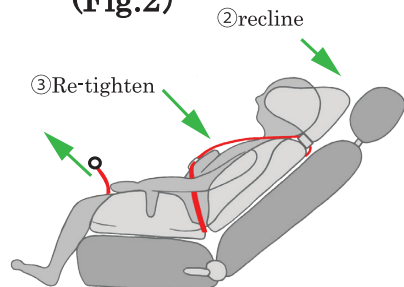

Features

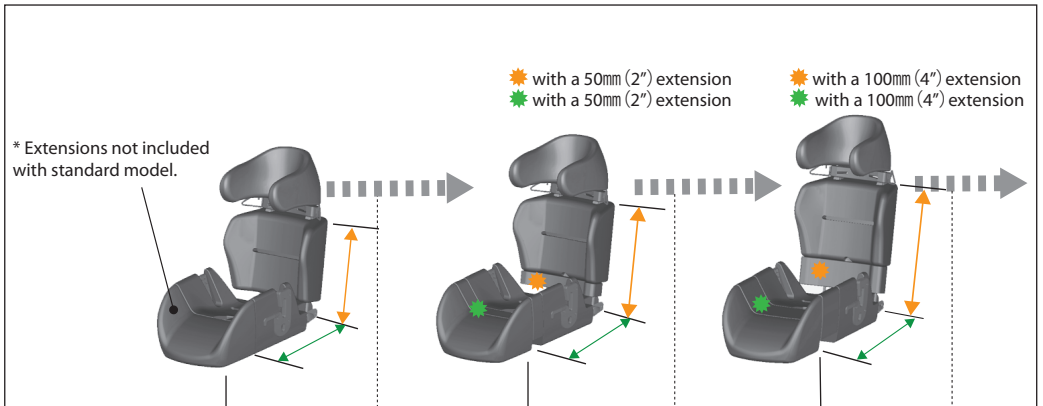
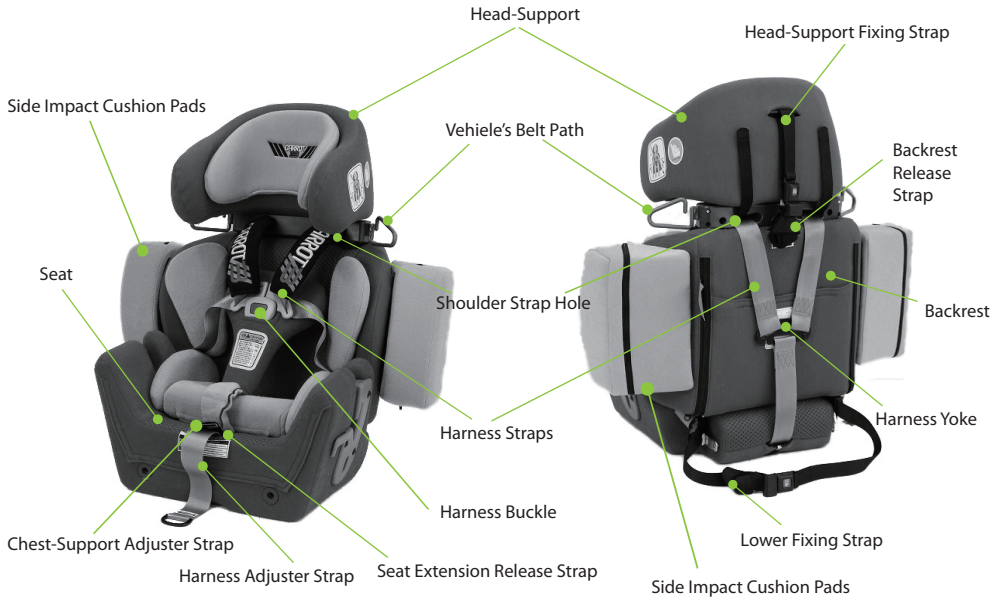

Shoulder Height	300mm (11.8")	325mm (12.8")	350mm (13.8")	375mm (14.8")	400mm (15.7")	425mm (16.7")
Seat Depth	250mm (9.8")	275mm (10.8")	300mm (11.8")	325mm (12.8")	350mm (13.8")	375mm (14.8")

Features

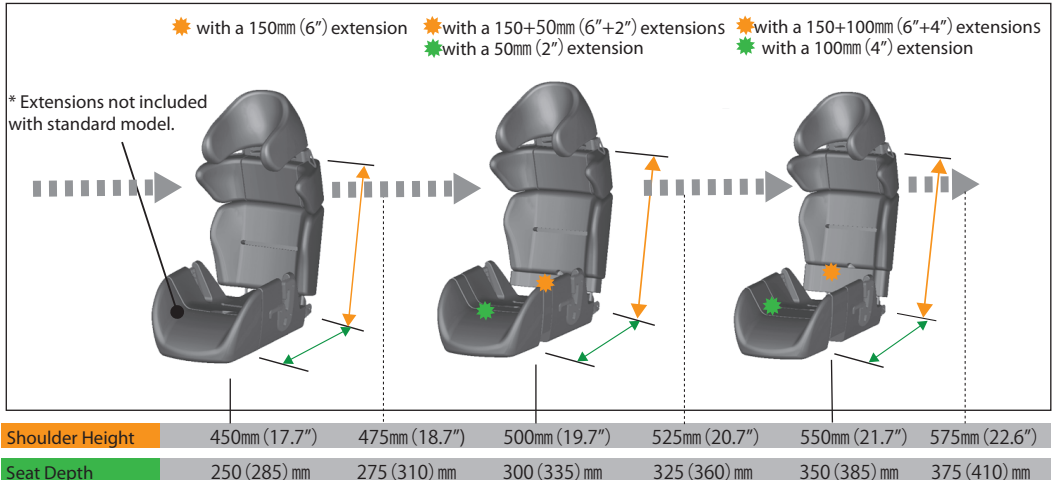

Installation

Standard Installation

Fixing Strap Installation

1. Installation using fixing straps provided at the upper and lower parts of the child seat.
2. Secure the Head-Support to the vehicle's headrest using the Head-Support fixing strap, and the child seat main body to the vehicle's seat using the lower fixing strap.
3. Attach the buckles, and push the child seat firmly into the vehicle seat while pulling both adjuster straps tight to remove all slack, and verify the child seat is secure (Fig. A and B).
4. Verify all connectors are secure and the child seat is secure.

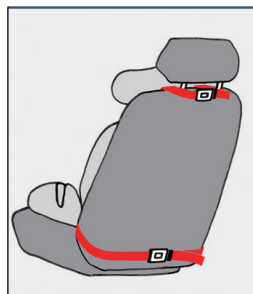

Fig. A
Image of Typical
Installation

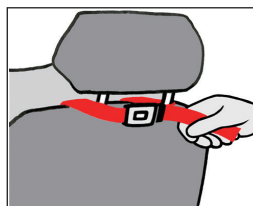

Fig. B

- When you install child seat to the passenger seat, in order to avoid potential impact by airbag, move the passenger seat backward as deep as possible.
- When you install child seat to the bench-seat, you may find that the fixing strap is too short to fix it sideways around. If this is the case you may fix child seat by using the strap vertically (Fig. C).
- When you find difficulty in securing the child seat, please contact the distributor or the retailer whom you purchased this child seat from for consulting.

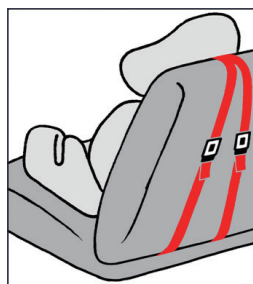
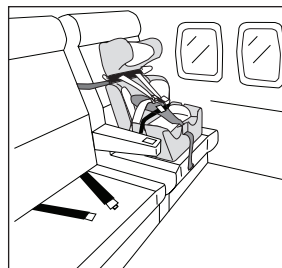

Fig. C

Installation

Aircraft Installation

Most airlines allow the use of a child restraint if it has been approved for airline use and properly fits into the aircraft. Contact your airline about their child restraint policy before traveling.



- The FAA recommends that a child weighing up to 18.1 kg (40 lbs) use a certified harness child seat while traveling on an aircraft.
- Install your child seat in a window seat to avoid blocking the aisle.
- If the aircraft lap belt is too short, ask a flight attendant for a belt extender.
- This seat may not fit in all aircraft. Contact your airline prior to travel to verify fit. Width of seat is 18”.
- This child restraint is FAA certified.



This Restraint is Certified for Use in Motor Vehicles and Aircraft.

Securing Your Child Restraint in Aircraft

The Federal Aviation Administration (FAA) recommends that you secure your child for air travel in an appropriate child restraint based on your child's weight and size. Turbulence can happen with little or no warning. When turbulence occurs, **the safest place for your child is in a properly installed child restraint, not in an adult's lap or on the aircraft seat with its seat belt.** Keeping your child in a child restraint during the flight will help ensure your family arrives safely at your destination.

The FAA recommends that a child weighing:*

- more than 18 kg (40 lbs) use an aircraft seat belt;
- from 9 to 18 kg (20 to 40 lbs) use a forward-facing child restraint.

*** Please note that these FAA recommendations may vary from those applicable to the use of your child restraint in a motor vehicle.**



Tutorial Video URL

Installation

Installation of Carrot-3 Fixing Strap

When you use the child restraint in an aircraft, you will need to use the Fixing Strap. This strap is long enough to tether the child restraint around the Aircraft seat. With this system you can fasten/unfasten and tighten/loosen the strap from either side of the seat so that the child restraint can be put at any seat in the aircraft.

Install the Fixing Strap prior to boarding aircraft. Visit the Tutorial Video (QR code) on page 10.

The set consists of three parts, two buckles and one center strap. No tools required for the installation. (Fig. A)

- First, unfasten the harness buckle. (Fig. B)
- Then press and hold the black buttons and removed head support. (Fig. C & D)
- Put the buckle pieces on the rods. There is no left or right side, but make sure the “PRESS” sign (in red) side always up. (Fig. E)
- Put the head support back onto the shoulder. (Fig. F)
- Confirm secure fixation with an audible click and response. (Fig. G)

Now you are ready to fasten/unfasten and tighten/loosen the center strap from both sides. (Fig. H)



Fig. A



Fig. B



Fig. C



Fig. D



Fig. E



Fig. F



Fig. G



Fig. H

Ask the distributor for installation assistance.

Installation

Installing The Child Restraint Forward-facing in Aircraft

- **IMPORTANT:** Before installing the child restraint, make sure the aircraft seat is in a fully upright position.
1. Adjust the child restraint to its upright position, then place it on the aircraft seat forward-facing. (Fig. A)
 2. Make sure that the back of the child restraint is firmly against the aircraft seatback.
 3. Attach the Fixing Strap around the back of the aircraft seat and tighten.
 4. Place child into the child restraint and attach the harness refer to page 17. Then install the aircraft seat belt through the lower belt guides (Fig. B) and over the child. Pull on the aircraft seat belt after securing the child, to ensure the aircraft buckle clasps are secure.
 5. Side impact cushion Pads can be removed when used in an aircraft.

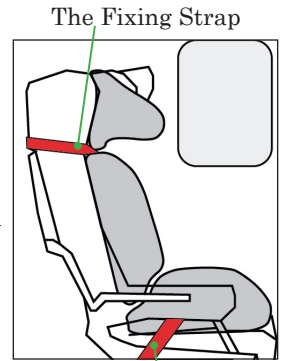

Fig. A
Aircraft Seat Belt

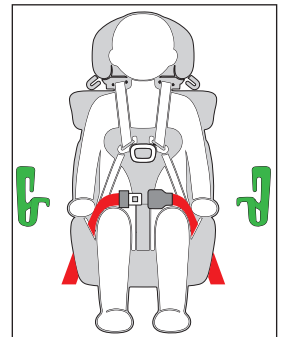

Fig. B

Check your work. Try to move the child restraint in all directions. If you can move the restraint more than 2.5 cm (1 in.) side to side or front to back at the forward-facing belt path, the Fixing Strap is not tight enough, and you **MUST** tighten the straps again until the seat is secure.

Functions

Head Section

Head Support Depth Adjustment

The Head Support can be adjusted forward or backward by 1.5 cm (0.6") increments to provide a better fit and added protection for the occupant (Fig. A).

To Adjust: Remove screws on each side of the head support with a Phillips screwdriver. Move the head support to selected position, and reinsert screws (Figs. B & C).



Fig. A

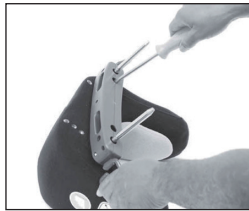

Fig. B

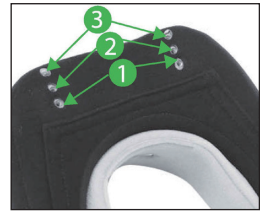

Fig. C (Use holes 1,2 or 3 on both sides)

Head Pillow Adjustment

The Head Pillow provides added comfort and positioning.

To reposition: Grasp the head pillow and pull it away from the head support. Place the head pillow where desired and press down to affix Velcro®



Functions

Shoulder Section

Harness Strap Adjustment

The Harness Strap comfortably positions the child in place.

To tighten the shoulder harness strap, pull on the harness adjustment strap (Fig. A).

To loosen the harness strap, press and hold the harness release lever (Red), while pulling the shoulder harness strap (Fig. B).

NOTE:

Do not pull on the padded covers or chest support pad when loosening the harness strap.

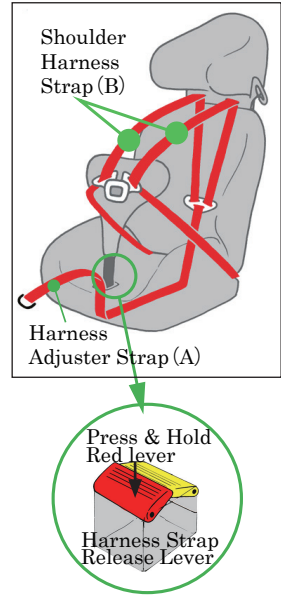

Harness Strap Length Adjustment

1. Turn the black knobs (left and right) counterclockwise and remove (Fig. A).
2. Separate the seat base from the backrest.
3. Pull the webbing (strap) out of the tube on the seat.
4. Replace the webbing (strap) utilizing the loop at the end of the webbing. Before replacing, fold the end of the loop and put it on the tube. This will make it easier to locate the hole on the tube to screw in the black knob (Fig. B).
5. Reattach the black knobs. Make sure that the black knobs are securely tightened (Fig. C).

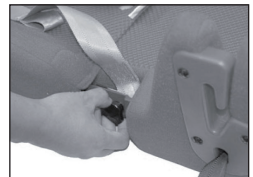

Fig. A

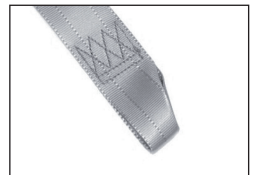

Fig. B



Fig. C

Functions

Shoulder Strap Comfort Pad

The shoulder strap comfort pad can be moved by readjusting the Velcro® attached to the back of the Head Support.



Shoulder Protector Wing

Optional Accessory

Adjusting Shoulder Width

Sideway extension adjustment of Shoulder Protector Wing is available by Max.100 mm, 50 mm each rightward and leftward respectively (five positions / 10 mm each).

Press and hold the shoulder width adjuster button (in Yellow) on the back, while pulling the wing outward to desirable position, where the body of child is secure and comfortable.

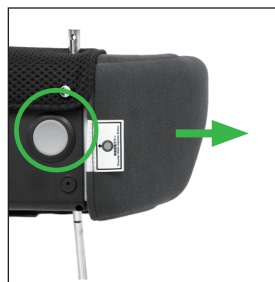
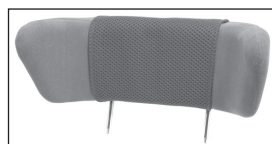

IMPORTANT :

When your child becomes big enough to use the Shoulder Protector Wing, you may purchase「Shoulder Protector Wing」for a larger child.

You must contact and ask the distributor for the installation and adjustment of the set.

Functions

Shoulder Protector Wing Installation

1. Detach the Shoulder Harness from the harness yoke (Fig. A).
2. Remove the harness and the Comfort Pads from the Head-Support unit (Fig. B).
3. Press and hold the Head-Support release buttons, and remove the Head-Support unit (Fig. C & D).
4. Remove two (2) screws on both right and left sides (Fig. E).
5. Insert the Head-Support rods into the Shoulder Protector Wing, and press together (Fig. F).
6. Align the holes located on the rods, insert the two (2) screws and tighten secure (Fig. G).
7. Attach the Head-Support/Shoulder Protector Wing unit to the Backrest unit. Re-thread the Shoulder Harness and the Comfort Pads, and reconnect to the harness yoke (Fig. H).



Fig. A



Fig. B



Fig. C



Fig. D

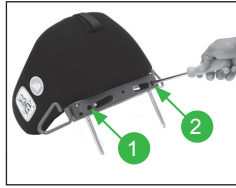

Fig. E

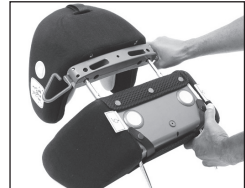

Fig. F

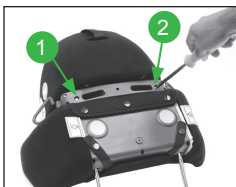

Fig. G



Fig. H



Tutorial Video URL

Ask the distributor for installation assistance.

Functions

Chest Section



WARNING!

Top level of the Chest-Support must be lower than throat area. Positioning the Chest-Support too high may risk your child choked.

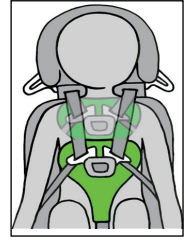

Adjusting Chest-Support

While pushing down the Chest-Support Height Adjuster lever (in Yellow) on the front of the child seat, adjust the height of Chest-Support to the appropriate position (Fig. A).



Fig. A

Fastening / Releasing Harness Buckle

1. Hold the harness buckle with one hand. Use the other hand to insert buckle tongues into the harness buckle (Fig. B). Proper connection is confirmed with a positive click after inserting each buckle tongue.
2. Brace the rear of the harness buckle with one hand. Press the release button and slide both tongues to remove from the buckle (Fig. C).



Fig. B



Fig. C

Functions

Backrest Section

IMPORTANT :

- Height of the Shoulder Harness Strap moves with the height of the Backrest.
- Level of the Shoulder Harness Strap must be at or above the Child's shoulders, parallel to level ground.

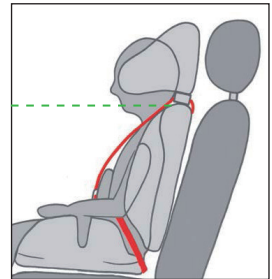

Adjusting Backrest Height

Release locking by pulling the Backrest Release Strap on the back of the child seat, and while pulling the Strap, adjust height of the Backrest.



Backrest Extensions (50 mm / 100 mm)

Optional Accessory

Backrest Extensions (50 mm / 100 mm) are provided to fill the space exposed between the backrest and the seat when you extend to the Backrest.

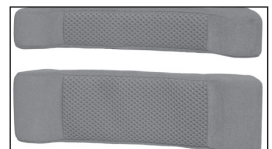

Functions

Side Impact Cushion Pads

The Side Impact Cushion Pads offer particularly good side impact protection, they absorb the forces as best as possible, especially in the head and shoulder area. They are attached to the outside of the backrest on the left and right with Velcro fasteners and are therefore easy to remove.



Side impact cushion Pads can be removed when used in an aircraft.

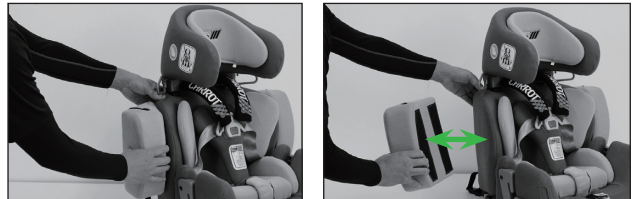

When attaching these cushion pads, attach them with the zippered side facing backward, as shown in the photo.

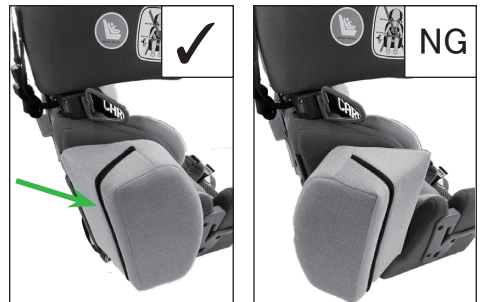

Functions

Seat Section

When a child sits with knees bent, adjust the total seat length slightly shorter than the length from pelvis to rear knee of your child.

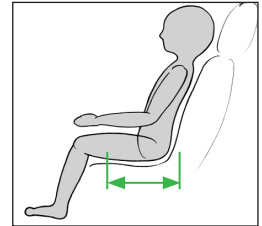

Adjusting Seat Length

Release locking by pulling the Seat Extension Release Strap on the front of the child seat, and while pulling the Strap, adjust position of the Rodded Seat Extension.

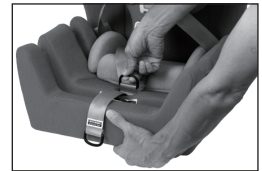

Seat Extensions (50 mm / 100 mm)

Optional Accessory

Seat Extensions (50 mm / 100 mm) are provided to fill the space exposed around the metal rods when you extend the Rodded Seat Extension and / or the Foot Rest.



Rodded Seat Extension-Long

Optional Accessory

Legs shall be stretched out, and lower limbs are to be supported as well.

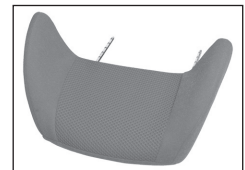

Rodded Seat Extension-Short

Optional Accessory

Knees are bent, and supporting up to femora.

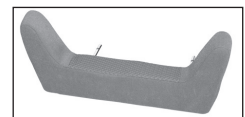

Functions

Adjusting Seat Depth

Seat depth can be adjusted by max. 35mm by changing position of Seat Depth Adjuster Knob.

Ask the distributor for adjustment and assistance.

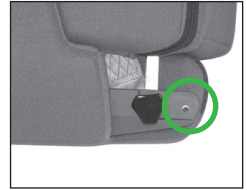

Foot Rest (Short / Medium / Long)

Optional Accessory

Three sizes of Foot Rest are provided to choose most appropriate one for your child. Release locking by pulling the Seat Extension Release Strap on the front of the child seat, and while pulling the Strap, adjust position of the Foot Rest. Vertical length of the Foot Rest is also adjustable by a spanner wrench.

Ask the distributor for adjustment and assistance.



Supporting Table

Optional Accessory

Supporting Table is provided when we can expect better secure of the child's upper limb by using it.



Seat Angle Adjuster Mat (Triangle Mat)

Optional Accessory

Use to increase and adjust the height and the angle of front area of the child seat for better secure and stability of child's seating.

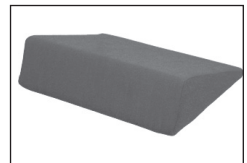

Functions

Pads and Cushions / Standard Accessories

Following Pads and Cushions are provided as standard accessories.

Attaching and Adjusting these pads and cushions can easily be done by Velcro for comfortable positioning to the child's body seating.

Head Pillow

Use to realize most comfortable and secure head position in the Head-Support.

Body Balance Pads

Use to realize most stable secure of the child's body balance in the child seat.

Seat Balance Pads

Use to realize most stable secure of the child's body balance in the child seat.

Comfort Cushion

Use to realize most comfortable position in the child seat and prevent the child's pelvis from slipping forward.

Side Impact Cushion Pads

The Side Impact Cushion Pads offer particularly good side impact protection.

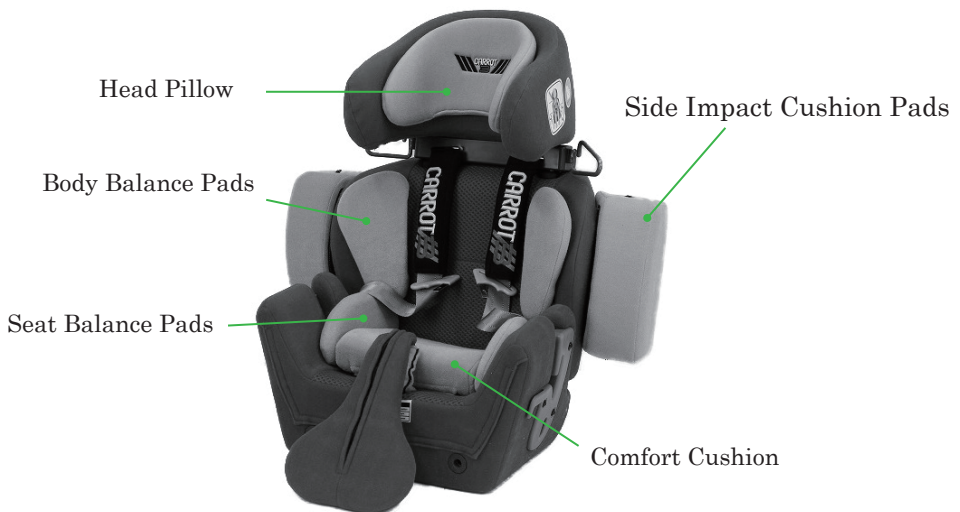

Functions

Anti Adduction / Knee Separator Pad

Optional Accessory

1. Unbuckle the harness strap.
2. Open the Velcro fastener and wrap around chest support harness to fasten.
3. The Anti Adduction / Knee Separator Pad can be attached forward or reverse facing.



Reverse facing shown



Tutorial Video URL

4. Removable Incontinence Receiver

Optional Accessory

1. Release harness strap to set aside.
2. Pull the chest support down in front of the seat.
3. Place the liner with the collar up.
4. Fit each corner well.
5. Tuck the side margins of the liner in between the backrest and the seat.
6. Place the chest support upright and fasten the collar around it.
7. Meet the front edges of the liner and the seat together.
8. Then fasten the front straps to the seat with Velcro®.
9. Then fasten the rear straps to the backrest with Velcro®.



Tutorial Video URL

Functions

Anti-Escape Vest

Optional Accessory

1. Detach the harness strap from the splitter plate.
2. Pull the harness strap out of the belt guide and shoulder belt pads.
3. Place the vest with the harness loops facing up (front).
4. Then the harness loops will face to the body as put on.
5. Put each harness strap through each side of the harness loops of the vest.
6. Put harness strap through the shoulder belt pads.
7. Then put harness strap through the black rings on top of the vest
8. Make sure the straps are not twisted before the rings.
9. Put the harness strap through the harness slots.
10. Attach the harness strap to the harness yoke.



Tutorial Video URL

Ask the distributor for installation assistance.

Hinge Lock Belt - for easy carrying

Optional Accessory

This Hinge Lock Belt makes carrying the Carrot 3 easier.

1. Slip the loop onto the red metal belt guide on the shoulder.
2. Unfasten the belt buckle on the strap.
3. Hook the belt through the red lap belt guide on the seat base, and then reconnect the buckle.
4. After reconnecting the belt, tighten the belt to bring the seat and back close together.
5. When not in use, always store the hinge lock belt in the backrest pocket along with the Carrot-3 user manual.



Tutorial Video URL

Securing Your Child

Once the child seat has been installed in the vehicle and adjustments have been made, follow these instructions to secure the child.

- Loosen the harness by pressing the harness strap release lever (in Red) on the front of the child seat, then pull the shoulder straps forward (Fig. A).
- Unfasten the harness buckle by pressing the release button and sliding the tongues out (Fig. B).
- Move the harness straps to the side of the child seat (Fig. C).
- Place the child in the child seat (Fig. D).
- Position the harness straps around the child and fasten the harness buckle. Proper connection is confirmed with a positive click after inserting each buckle tongue (Fig. E).
- Gently pull up on the harness straps to tighten the lap section, which should fit low on the child's body (Fig. F).
- Slowly pull the harness adjuster strap to tighten the harness around the child (Fig. F).
- Verify that the harness (5-point) is not twisted and child is properly secured.
- After you secured child with the harness (5-point) of the child seat, fasten vehicle's lap shoulder (3-point) safety belt over the child seat routing through the belt path on the the shoulder and the lap belt guides (red plastic parts) at both sides of the child seat (Fig. G). Proper connection is confirmed with a positive click sound after inserting the buckle tongue of the vehicle's lap shoulder (3-point) safety belt into the buckle of the vehicle's seat.
- The child's hip should be positioned as deep as possible to firmly secure.
- Verify that the vehicle's lap shoulder (3-point) safety belt is not twisted or sagging, properly routed through the belt path and the belt guides of the child seat. It is necessary that the buckle of the vehicle's seat should be positioned lower than the belt guides of the child seat to firmly secure the child.



Fig. A



Fig. B



Fig. C



Fig. D



Fig. E



Fig. F



Fig. G

Securing Your Child

If you find the buckle of your vehicle's seat is higher positioned than the belt guides of the child seat, consult your dealer for support and solution.

- Make sure that the vehicle's lap shoulder (3-point) safety belt is positioned not to harm the face and/or the neck of the child.
- It is required by law to use the vehicle's lap shoulder (3-point) safety belt at the same time to secure a child seat and child.
- Before every trip, make sure that the vehicle's lap shoulder (3-point) safety belt is firmly fastened over the child seat, and the child is secure.
- Verify that the Chest Support (Heart-shaped pad) is at the position that guarantees the lap belt stays appropriately to hold the hip of the child as deep as possible.

If you feel insecure about appropriate positioning of your child and the child seat, do not hesitate to consult your dealer for support and solution.



WARNING!

It is your RESPONSIBILITY to use Vehicle's Safety Belts at the same time.

It is NOT enough to secure a child only with (5-point) harness straps of the child seat, and is required by law to always use the vehicle's lap shoulder (3-point) safety belt at the same time to secure a child seat and child.

Without using vehicle's lap shoulder (3-point) safety belt could cause your child seat not to perform as intended and risk your child Death or Serious Injury.

Figure A. below illustrates a lap shoulder (3-point) safety belt secures over the child seat.

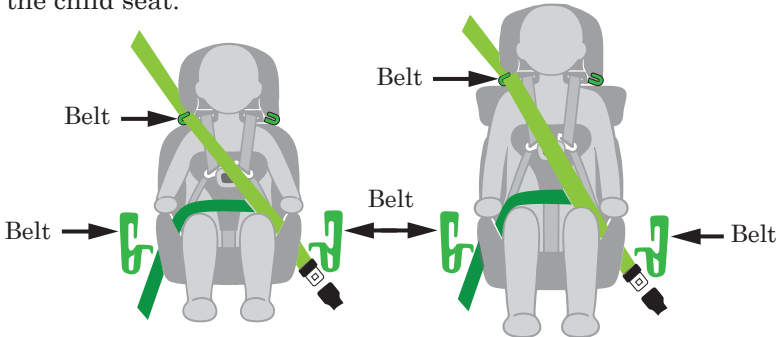

Securing Your Child

IMPORTANT :

- Always pull on the harness after securing the child to ensure the buckle tongues are secure in the harness buckle.
- Always park your car at the safe place when you make any adjustments to child seat including reclining the car seat. Adjusting and / or handling child seat during driving could risk both you and your child for DEATH or SERIOUS INJURY.
- During driving, child seat shall be used at the position as upright as possible. Too much reclined position could cause your child seat not to perform as intended in a collision.



WARNING!

Before reclining the back, you must release and loosen the harness straps (Fig.1). Once reclined, re-tighten the harness straps (Fig. 2).

Reclining the back without loosening the harness straps may cause choking.

The Carrot-3 was tested at a 30° recline from vertical, and should not be transported in a moving vehicle past this point.

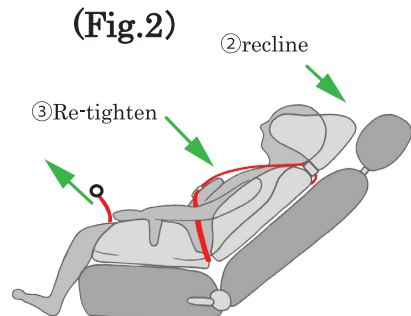
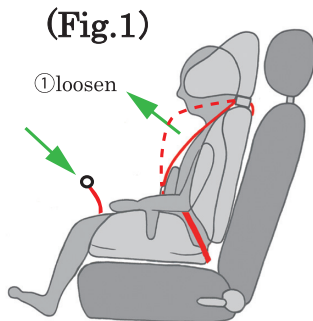

Care and Maintenance

Cover Removal

Do not try to remove or replace the cover by yourself as it is complicated and needs equipments. Ask the distributor for removal or replacement of the cover.

Do not take apart or attempt to take apart the harness. Never remove the buckle tongues from the harness. They cannot be reattached after removal. If reassembled incorrectly, the child seat may not perform as intended.

Cleaning the Cover, Pillow and Pads

For the Cover, SPONGE CLEAN using cold water and mild soap. TOWEL DRY. For the Pillow and Pads and Cushions, HAND WASH using cold water and mild soap. LINE or LIE FLAT DRY to prevent them from shrinking. Do not Bleach, machine wash, machine dry or iron. To keep them clean is important but washing may damage those fabrics. When you find damages on fabric, it is time to replace it. And periodical replacement is recommended.

A Click Sound of the Harness Buckle

If a child eats and drinks while in the child seat, the harness buckle may need to be periodically checked of its performance.

If a positive click is not heard, it is time to replace the harness buckle. Ask the distributor for replacement of the harness buckle.

The Harness and The Straps

Do not take apart or attempt to take apart the harness and the straps from the child seat. Never remove the buckles and / or the buckle tongues from the harness or the straps. They cannot be reattached after removal. If reassembled incorrectly, the child seat may not perform as intended.

Product Dimensions

Overall Width (with the Shoulder Protector Wing Set) (460~560 mm) (with the Side Impact Cushion Pads) (560 mm)	420 mm	Product Weight (with the Shoulder Protector Wing)(10.5kg)	8.7 kg
Seat Depth	250~410 mm	Target User Weight	10~49 kg
Seat Width	260 mm	Target User Age	2~15 years
Extendable Backrest Height (with the Shoulder Protector Wing Set)(670~795 mm)			

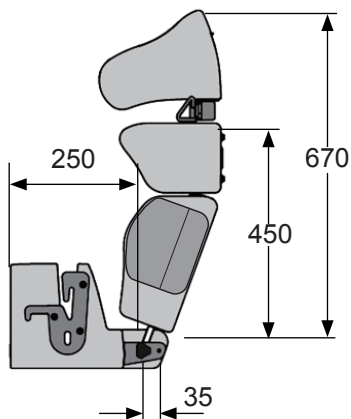
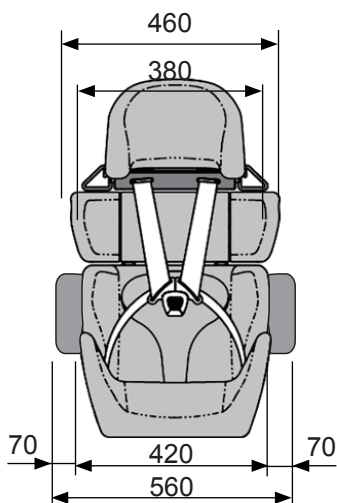
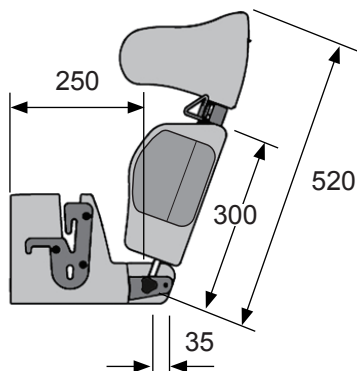
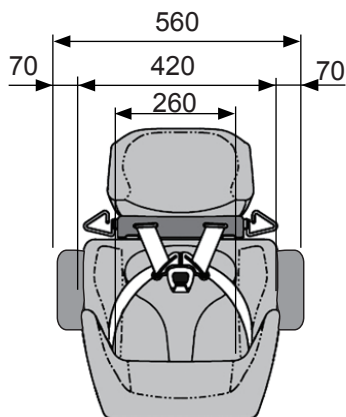

Warranty

LIMITED TWO-YEAR WARRANTY

This product is warranted against defective materials and workmanship for two years from the date of original purchase. Proof of purchase is required.

To make a claim under this warranty, contact the authorized distributor or the retailer whom you purchased this product from. Proof of purchase is required.

WARRANTY LIMITATIONS

This warranty does not include damages which arise from negligence, misuse or use not in accordance with the product instruction.

The use of non-CARROT-3's covers, inserts, toys, accessories, or tightening devices is not approved. Their use could cause this child seat to fail Safety Standard, ECE regulation No.16, or not to perform as intended in a crash. Their use automatically voids this warranty.

LIMITATION OF DAMAGES

The warranty set forth above is exclusive and in lieu of all others, oral or written, express or implied. In no event will the manufacturer, the distributors, or the retailers selling this product, be liable for any damages, including incidental or consequential damages, arising out of the use or inability to use this product.

Warranty

LIMITED TWO-YEAR WARRANTY

Product Model Number : CARROT - 3

Your Name:

Your Street Address:

City:

State:

Zip Code

Country:

Telephone Number:

E-mail Address:

Date of Purchase:

Distributor

General Agency